

Instructions for installation,
use e maintenance

GAS FRY TOP

ADN 632 · ADN 633

ADN 634 · ADN 635



CHARACTERISTICS

Supplied by:

Date:

Customer Service:



FAX

e-mail

INDEX

1 Diagram	4
2 Characteristics of the appliances	5
3 Technical data	5
4 Installation instructions	6
4.1 Safety rules	6
4.2 Structure, framework and safety devices of the appliances	6
4.3 Assembly	6
4.3.1 Installation premises	6
4.3.2 Statutory regulations and technical requirements	6
4.3.3 Installation	6
4.3.4 Gas connection	6
4.3.5 Smoke extraction	6
5 Operation preparation	7
5.1 Preparation and Start-up	7
5.1.1 Start-up	7
5.1.2 Check of power	7
5.1.3 Checking the input pressure	7
5.1.4 Power check with volumetric method	7
5.1.5 Power check for operation with liquid gas	8
5.1.6 Operation control	8
5.1.7 Checking the primary air	8
5.1.8 Operator training	8
5.1.9 Conversion and adjustment	8
5.1.10 Replacement of burner injector fry top 400	8
5.1.11 Replacement of burner injectors fry top 600	8
5.1.12 Setting reduced capacity power	9
5.2 Maintenance	9
5.3 Replacing parts	9
5.3.1 Gas cock	9
5.3.2 Thermocouple	9
5.3.3 Plug	9
5.3.4 Burner fry top 400	9
5.3.5 Burner fry top 600	9
6 Instructions for use	10
6.1 Safety, cleaning and repair rules	10
6.2 Start-up	10
6.2.1 Lighting and disconnecting of burner	10
6.3 Cleaning and taking care of the machine	10
6.4 Turning the appliance off in case of breakdown	10
6.4.1 What to do in case of failure	10
6.4.2 What to do in case of prolonged period of disuse	10
6.5 Appliance care and frequency of maintenance	10
6.6 Recommendations for handling "stainless steel" industrial kitchens	11
6.6.1 Useful information on "stainless steel"	11
6.6.2 Warnings and advice for maintenance of "stainless steel" appliances	11
6.6.3 WEEE Directive	11



1 - DIAGRAM

**ADN 634
ADN 635**

**ADN 632
ADN 633**

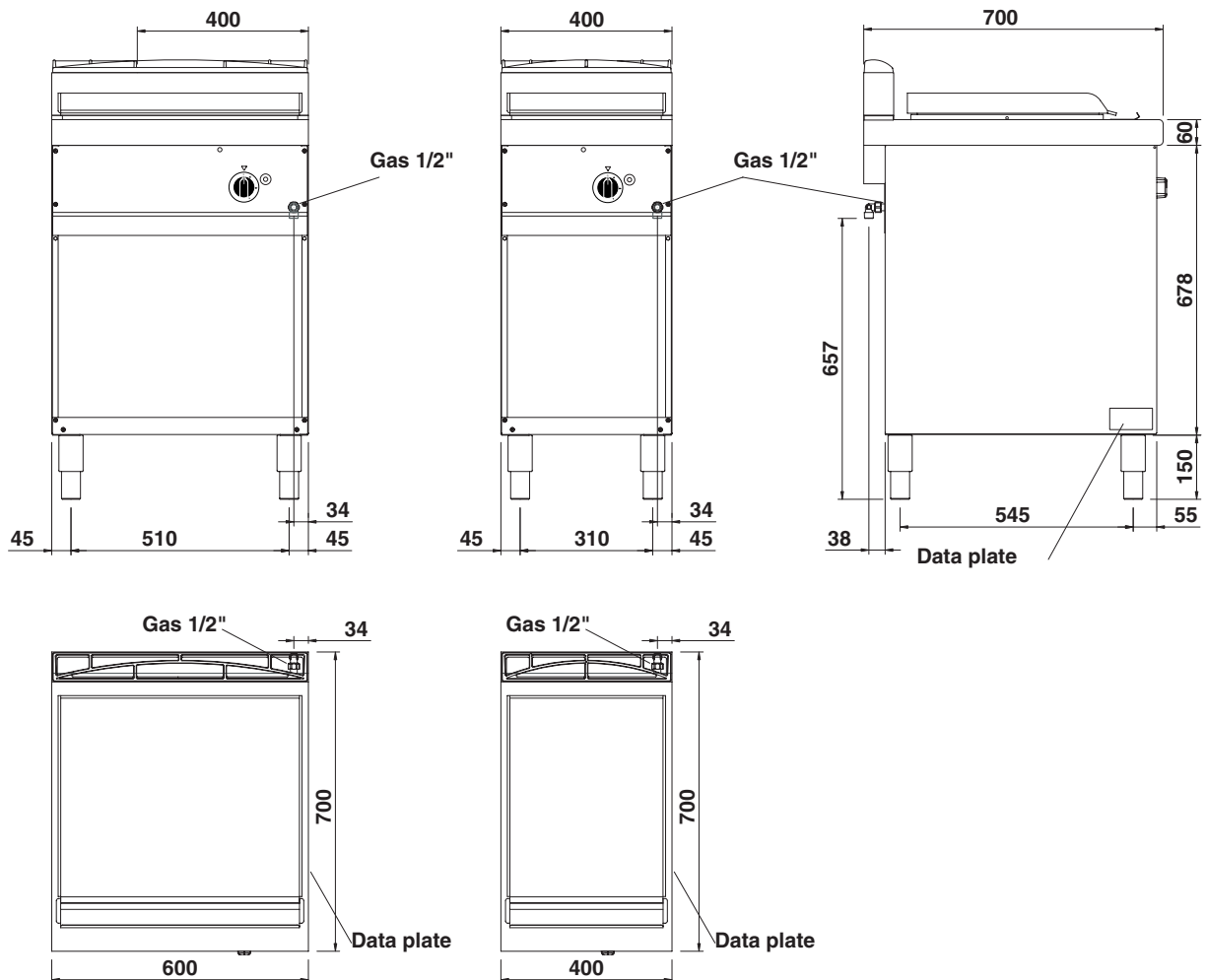

2 - CHARACTERISTICS OF THE APPLIANCES

These appliances are used for professional purposes. Installation, repair and use must be carried out by expert personnel.

These instructions for installation are for our gas fry top set up for the category in the table 1 on pag. 5. The data plate is located on the appliance, see diagram. Beware of inexpert handling.

	CATIKAT	GAS/GAZ	G30	G31	G20	G25	SE <input type="checkbox"/> FI <input type="checkbox"/> DK <input type="checkbox"/> CZ <input type="checkbox"/> SK <input type="checkbox"/> SI <input type="checkbox"/>			
	II2H3B/P	P mbar	30	30	20	-	IT <input type="checkbox"/> CH <input type="checkbox"/> PT <input type="checkbox"/>			
	II2H3+	P mbar	30	37	20	-	ES <input type="checkbox"/> IE <input type="checkbox"/> GB <input type="checkbox"/> GR <input type="checkbox"/>			
	II2L3B/P	P mbar	30	30	-	25	NL <input type="checkbox"/>			
	II2EL3B/P	P mbar	50	50	20	20	DE <input type="checkbox"/>			
TIPO/TYPE	II2E+3+	P mbar	28	37	20	25	FR <input type="checkbox"/> BE <input type="checkbox"/>			
MOD.	II2H3B/P	P mbar	50	50	20	-	AT <input type="checkbox"/> CH <input type="checkbox"/>			
ART.	II2E	P mbar	-	-	-	-	LU <input type="checkbox"/>			
CE N.	II2H3B/P	P mbar	30	30	-	-	EE <input type="checkbox"/> LV <input type="checkbox"/> LT <input type="checkbox"/>			
N.	II2H3+	P mbar	28	37	20	-	EE <input type="checkbox"/> LV <input type="checkbox"/> LT <input type="checkbox"/>			
% Qn kW	II3B/P	P mbar	30	30	-	-	NO <input type="checkbox"/> MT <input type="checkbox"/> CY <input type="checkbox"/> IS <input type="checkbox"/> HU <input type="checkbox"/>			
MOD.	II3+	P mbar	28	37	-	-	CY <input type="checkbox"/>			
Predisposto a gas: - Gas preset: - Prevu pour gaz: Eingestellt für Gas: - Preparado para gas: - Geschuckt voor:										
V AC	kW		Hz		MADE IN ITALY					
THE APPLIANCE MUST BE CONNECTED IN COMPLIANCE WITH THE LAWS IN FORCE AND INSTALLED IN A WELL-VENTILATED ROOM. READ THE INSTRUCTION MANUALS BEFORE INSTALLING AND USING THE APPLIANCE. THE APPLIANCE MUST BE INSTALLED BY QUALIFIED PERSONNEL.							G30/G31 28/37 mbar			
							G20 20 mbar			

3 - TECHNICAL DATA

Model	Description	Dimensions in mm. (LxDxH)	Area plate	N. CE
ADN 632	Smooth plate gas Fry Top	400 x 700 x 900	0,165 dm ²	51BS3544
ADN 633	Grooved plate gas Fry Top	400 x 700 x 900	0,165 dm ²	51BS3544
ADN 634	Smooth plate gas Fry Top	600 x 700 x 900	0,256 dm ²	51BS3544
ADN 635	Smooth/grooved plate gas Fry Top	600 x 700 x 900	0,256 dm ²	51BS3544

TABLE 1

Model	ADN 632	ADN 634		
	ADN 633	ADN 635		
Category	II2H3+			
Construction type	A			
Air necessary for combustion	m ³ /h	9.5	16	
Nominal thermal power	kW	4.5	7.0	
Minimum thermal power	kW	0.9	2.1	
Overall thermal power (gas)				
Connection pressure				
Methane gas 2H	G20	20 mbar		
Liquid gas 3+	G30/G31	28/37 mbar		
Gas connection values				
Methane gas 2H	(HuB = 9.45 kWh/m ³) in m ³ /h	0.476	0.741	
Liquid gas 3+	(HuB = 12.87 kWh/kg) in kg/h	0.355	0.552	
Nozzles Ø 1/100 mm				
Main burner	G20	Nominal thermal power	160	2 x 145
		Minimal thermal capacity	Adjustable	Adjustable
	G30/G31	Nominal thermal power	110	2 x 95
		Minimal thermal capacity	45	75
No. of nozzles pilot burner				
	G20	27	35	
	G30/G31	19	20	
Primary air distance "A" mm				
	Methane gas G20	5	1	
	Liquid gas G30/G31	5	4	

4 - INSTALLATION INSTRUCTIONS

4.1 Safety rules

- Only a local gas utility technician is authorized to carry out gas installations and connections. The statutory regulations (applied in Germany VDE, Austria ÖVE, Switzerland SEV, etc.) and connection conditions performed by the gas utility must be strictly observed.
- In compliance with international regulations, when connecting the appliance to the mains power supply, a device with a minimum aperture of 3 mm between contacts must be fitted upstream of the appliance, allowing omnipolar disconnection of the appliance from the mains. Also, a high-sensitivity automatic differential switch must be installed which protects against direct or indirect contact with live electrical parts and against current leakage (maximum current leakage permissible by regulations is 1 mA/kW).
- Connection to a power balance system for the installation in a all is given through a connection point. Follow the VDE 0100 T 410 connection rules or local rules.
- Compare technical datas on grey stickers to those written on this manual and present power supply.
- Do not bend, crush or damage the cables against sharp corners.
- Lay the cables so as to avoid contact with extremely hot surfaces.
- Connection to the grid must be carried out with at least a cable type NYM or H07RN-F.
- The cable - which is totally sheathed - must be led inside the appliance through the cable clamp and cable raceway installed on the appliance.
- Ventilation system installation can be carried out only by expert personnel.
- If the appliance is to be installed near walls, dividing walls, kitchen equipment or decorative panelling, these should be in non-flammable material. If not, all appliances must be coated with thermal-insulation fireproof material. Make sure that all fire prevention standards and safety precautions are strictly adhered to.

4.2 Structure, equipment and safety devices of the unit

Robust steel frame, with 4 height adjustable feet.

Steel outer panelling.

The surface of the plate can be either smooth or grooved, the plate comes with side and back splashguards. The appliance is also fitted with a stainless steel fat tray.

The plate is heated by tubular chromium-plated steel burners, built to withstand thermomechanical stress.

The combustion chamber and flues are made of electrogalvanised steel sheeting.

4.3 Assembly

4.3.1 Installation premises

The appliance must be installed in a well-ventilated room, and if possible under a range hood (check current regulations).

The appliance can be installed on its own or with other similar equipment.

If the appliance is to be installed near inflammable walls, a minimum distance of 150 mm around the sides and back should be allowed.

If this distance cannot be obtained, take proper heat-protection action such as fitting tiles or thermal radiation protection material to the walls.

Before connecting the appliance to the gas supply, check on the data plate that the appliance is suitable and type-tested for the type of gas available.

If the type of gas indicated on the data plate of the appliance does not correspond to the gas which is present, refer to the paragraph 5.1.9 "Conversion and adaptation".

4.3.2 Statutory regulations and technical requirements

During installation of the appliance, the following regulations must be adhered to:

- Relevant legal directives;
- Local building and combustion regulations;
- "Technical rules for gas systems" worksheet;
- "Technical rules for liquid gas" worksheet;
- "Gas installations in industrial kitchens" worksheet;
- Relative accident prevention standards;
- Local gas utility regulations;
- Local building and fire codes.

4.3.3 Installation

Before installation, gas connection, power check, conversion or adjustment and start up ask for gas supply company advice.

4.3.4 Gas connection

For the gas connection an L-type 1/2" adjustable connector is provided, complete with seal, to be fitted at the mouth of the apparatus gas train. The connection to the mains can be fixed or detachable by inserting a suitable type-tested tap.

If hoses are used, they must be in stainless steel and in compliance with the DIN 3383, part 1 or DIN 3384 regulations.

After completing gas connection, check for leaks using a special leak-detector spray.

4.3.5 Smoke extraction

These fry top are type A appliances, thus no smoke extraction system is required.

For the ventilation of the room where the appliance is installed, refer to related legislation.

5 - SET-UP FOR OPERATION

5.1 Preparation and Start-up

Before starting up the appliance, remove the protective wrapping. Then carefully clean the working surface and the external parts with lukewarm water and detergent, using a damp rag to remove all traces of anti-rust material applied in the factory, then dry with a clean cloth. Protect cooking plate with oil or grease.

5.1.1 Start-up

Before using the appliance for the first time, thoroughly clean out the griddle (see the chapter 6.3 "Cleaning and taking care of the machine").

Before starting up the appliance, check that its specifications (category and type of gas used) match those of the family and group of the gas available locally.

If not, it is necessary to adapt the appliance to the gas family or group required (see paragraph 5.1.9 "Conversion and adaptation").

To start up the appliance, see the instructions for regular use.

5.1.2 Check of power

The appliances must be used with the specific injectors for the nominal power.

The power may be:

- the nominal power indicated on the data plate of the appliance;
- the reduced capacity power.

These injectors are shown in table 1.

Nominal power is also obtained in respect of the supply pressure:

- from 15 to 22.5 mbar for gases of the second family (G20/methane)
- from 25 to 45 mbar for gases of the 3rd family (G30/butane, G31/propane)

The appliance shall not be operated outside the above-mentioned pressure ranges.

To adjust power with reduced capacity, use the data in table 1.

If you wish to further check the nominal power, you may do so by using a gas meter according to the so-called "volumetric method".

A simple inspection is usually enough to check if injectors are functioning correctly.

5.1.3 Checking the input pressure

Input pressure should be measured using a fluid measuring gauge (e.g. a gooseneck pipe, min. resolution 0.1 mbar).

Remove lock screw (pos. 10 fig. 1) from the pressure intake tube and connect the gauge hose: once measurement is complete, replace the screw and do a seal check using a leak detector spray.

5.1.4 Power check with volumetric method

Using a gas meter and a stopwatch, you can read the volume of gas output per time unit. The correct volume corresponds to the value "E" expressed in litres/hour (l/h) or litre/minute (l/min).

The following formula is used to calculate the value of "E":

$$E = \frac{\text{Power}}{\text{Operating calorific value}}$$

It is important measure the power when the appliance is in standby status.

The calorific power value can be requested from the local gas company.

The nominal power and the minimum power with respect to the nominal pressure are obtained by consulting the table for the adjustment of the gas passage (table 1).

WARNING

 There is no pre-adjustment device for the nominal power.

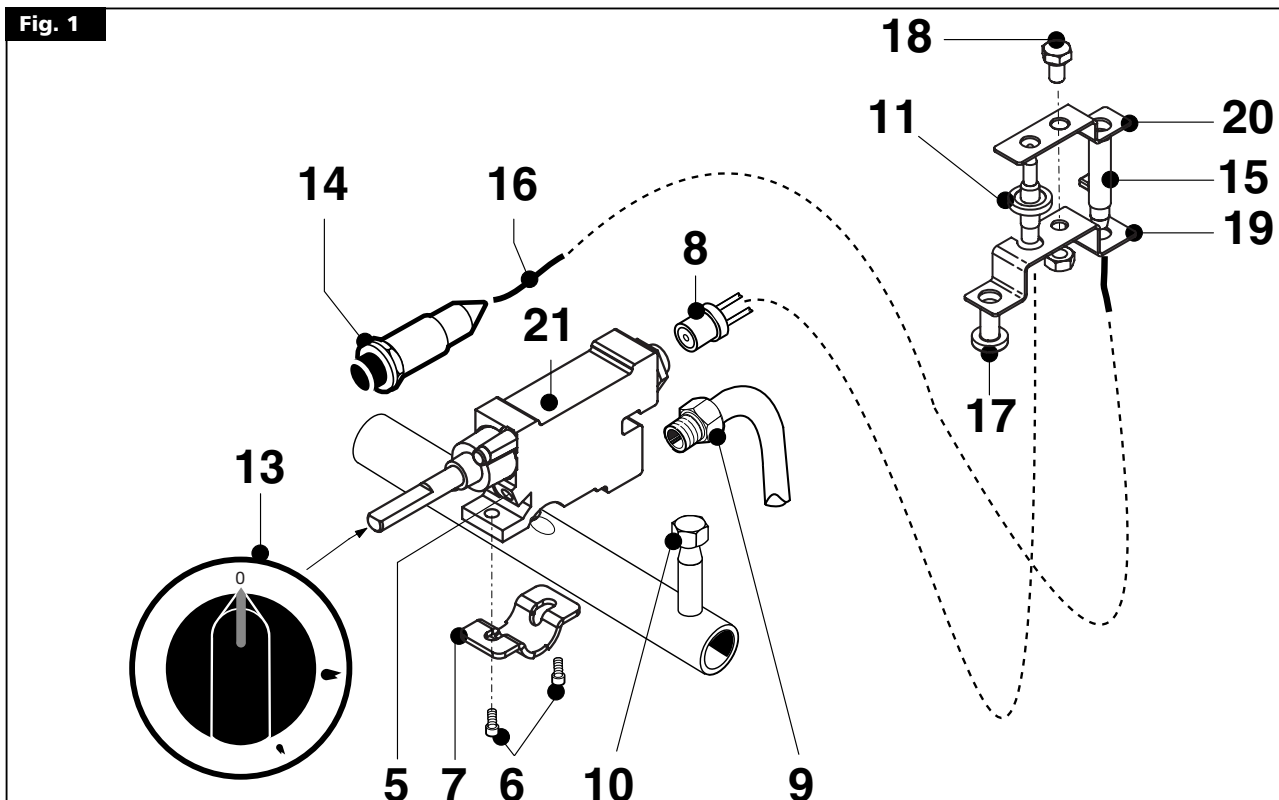

5 - SET-UP FOR OPERATION

5.1.5 Power check for operation with liquid gas

Check if the type of injectors used meet the data of the table 1.

Check that the pressure reducer installed in the system has an outlet pressure which is compliant with paragraph 5.1.2 "Check of power" (can be checked on the data plate of the appliance or on the table 1).

5.1.6 Operation control

- Start the appliance in accordance with the instructions.
- Check that the appliance does not have any leaks by using a leak-detecting spray.
- Check ignition and that flame on the main burner lights properly and is correctly formed, even on low.
- A servicing and maintenance contract is recommended.

5.1.7 Checking the primary air

The burners are equipped with primary air adjustment. Distance "A" (fig. 2A and fig. 2B) see table 1.

Air volume flow is correct when there is sufficient protection against the flame rising when the burner is cold or in case of flashback when the burner is hot.

5.1.8 Operator training

- Explain and show the user how the machine works according to the instructions, and hand him this manual.
- Remind the user that any structural alterations or any building modification or renovation may affect the combustion air supply, thus requiring a second operation check.

5.1.9 Conversion and adjustment

To change over from one kind of gas to another, for example from methane to liquid gas, or to another type of gas, the use of suitable injectors for the main burner is required, in accordance with the table 1.

The injectors of the main burners for different types of gas, marked with the relative diameter in hundredths of mm, are in an envelope which is provided with the appliance. If injectors are not available please contact the factory with model and serial number written on technical data sticker. After transformation or adaptation, carry out operating checks as described in paragraph 5.1.6 "Operation control".

5.1.10 Replacement of burner injector fry top 400

To replace the injector (pos. 1 fig. 2A) unscrew the screw (pos. 2 fig. 2A) fixing the burner (pos. 3 fig. 2A) to the injector-holder nut (pos. 4 fig. 2A), lift up the burner until catch up the injector and replace the injector with one able for the type of gas, see table 1, install in reverse order.

After fitting the new injectors, reset primary air distance "A" (fig. 2A) see table 1, and fasten the bushing with the appropriate screw. After the replacement check the seal using a leak detector spray.

5.1.11 Replacement of burner injectors fry top 600

To replace the injectors (pos. 1 fig. 2B) unscrew the screws (pos. 2 fig. 2B) fixing the burners (pos. 3 fig. 2B) to the injector-holder collector nuts (pos. 4 fig. 2B), lift up the burners until catch up the injectors and replace the injectors with one able for the type of gas, see table 1, install in reverse order.

After fitting the new injectors, reset primary air distance "A" (fig. 2B) see table 1, and fasten the bushing with the appropriate screw..

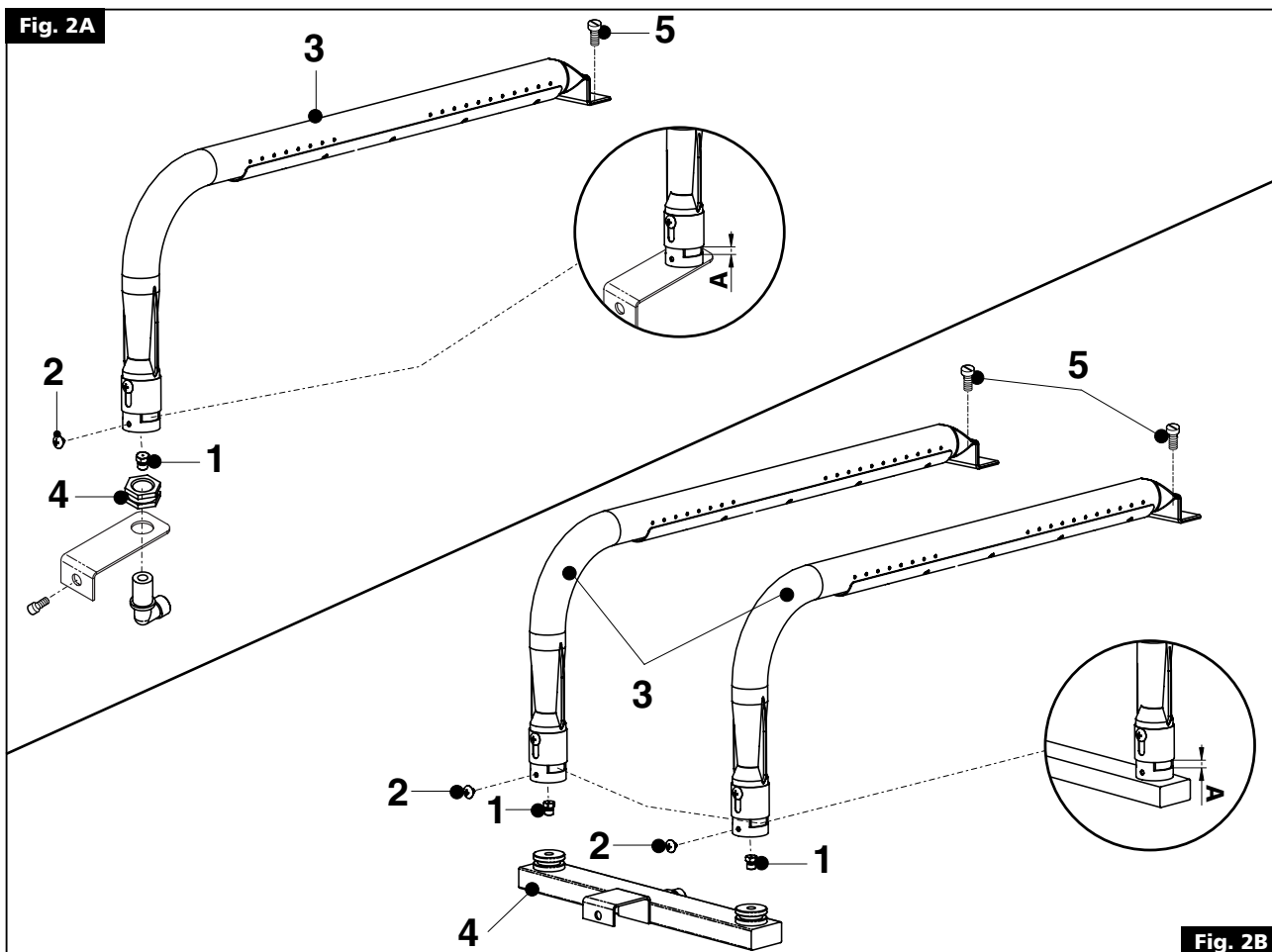

5 - SET-UP FOR OPERATION

After the replacement check the seal using a leak detector spray.

5.1.12 Setting reduced capacity power

The minimum setting screw (pos. 5 fig. 1) should be adjusted as follows:

- for operation with LPG it should be screwed all the way down;
- for operation with methane, use the gas flow table to check the value in l/min with respect to the operating orific value (measurement in accordance with the volumetric method). Start the appliance in accordance with the instructions. Turn the knob to the minimum position and use screw (pos. 5 fig. 1) to adjust the flow (clockwise = flow reduction; counter-clockwise = flow increase).

5.2 Maintenance



Attention! Before doing any repair or maintenance work, unplug the appliance.

The following maintenance program should be carried out at least once a year by qualified personnel with license:

- Check that all the safety and adjustment devices are working properly;
- Check that the burners are working properly with regard to:
 - ignition
 - combustion safety;

Check functioning of the appliance as described in paragraph 5.1.6 "Operation control".

5.3 Replacing parts



All parts must be replaced by authorized technicians only!

To replace the following parts first remove all the control knobs and control panel (after loosening the fixing screws), then extract the ignition wire.

5.3.1 Gas cock

Loosen the fitting of the pipe (pos. 9 fig. 1) of the gas, unfix the graft (pos. 8 fig. 1) of the thermocouple, unscrew the two screws (pos. 6 fig. 1) fixing the cock on the gas piping through the hanger (pos. 7 fig. 1) and replace the piece (pos. 17 fig. 1) install in reverse order install paying attention to the seal ring. After the replacement check the seal using a leak detector spray.

5.3.2 Thermocouple

Unfix the graft (pos. 8 fig. 1) fixing the thermocouple on the cock, unscrew the screw (pos. 17 fig. 1) fixing the support thermocouple /plug (pos. 19 fig. 1) on the combustion chamber and pull down the support to a more convenient position, unscrew the screw (pos. 18 fig. 1) fixing the fixing plate (pos. 20 fig. 1) and replace the piece (pos. 11 fig. 1) install in reverse order.

5.3.3 Plug

Unfix the cable (pos. 16 fig. 1) from the piezo ignition, unscrew the screw (pos. 17 fig. 1) fixing the support thermocouple /plug (pos. 19 fig. 1) on the combustion chamber and pull down the support to a more convenient position, unscrew the screw (pos. 18 fig. 1) fixing the fixing plate (pos. 20 fig. 1) and replace the piece (pos. 15 fig. 1) install in reverse order.

5.3.4 Burner fry top 400

Unscrew the screws (pos. 2 and 5 fig. 2A) fixing the burner to the injector-holder nut (pos. 4 fig. 2A) and on the combustion chamber, lift up the burner (pos. 3 fig. 2A) for pull off from the injector-holder, pull off and put in a new piece in the reverse order. After the replacement check the seal using a leak detector spray.

5.3.5 Burner fry top 600

Unscrew the screws (pos. 2 and 5 fig. 2B) fixing the burner to the injector-holder collector nuts (pos. 4 fig. 2B) and on the combustion chamber, lift up the burner (pos. 3 fig. 2B) for pull off from injector-holder collector, pull off and put in a new piece in the reverse order. After the replacement check the seal using a leak detector spray.















After any maintenance or repair work, replace the control panel and the lower panel.

After replacing gas input components, check operation again and test for leakage.

6 - INSTRUCTIONS FOR USE

6.1 Safety, cleaning and repair rules

-  • This appliance is used for the preparation of meals at industrial level. Usage and cleaning can be carried only by expert personnel. Maintenance and repair can be carried out only by skilled technical personnel.
-  • These indications must be communicated to all those concerned during internal training.
-  • Attention! This appliance must be constantly watched over when being used!
-  • Grease and overheated oil can catch fire. Use this appliance only under constant control. Never use water to put out grease or oil!
-  • Do not leave the burners running.
-  • Parts of the appliance and attachments exposed to food must be cleaned with detergents and rinsed thoroughly with potable water.
-  • Do not clean the appliance using water jets or steam, whether direct or pressurized!
-  • If the room is being cleaned with water/steam jets or high-pressure equipment, it is necessary to switch off the appliance first!
-  • Before starting to clean the appliance, disconnect from the mains.
-  • Do not use inflammable liquid to clean the appliance.
-  • Repairs may be carried out only by skilled personnel.
-  • During repairs, the appliance must undergo voltage omnipolar insulation (local switch, i.e. safety load cut-off switch).
-  • Noise emission values of the appliance in operation are below 70dB (A). This value is compulsory according to certain national safety standards.

WARNING

-  **Attention!** The manufacturer declines all responsibility concerning mistakes included in these instructions due to translating or printing errors: the manufacturer also reserves the right to change the product as he sees fit, though without changing its essential features. The manufacturer declines all responsibility for any non-compliance with the provisions contained in this manual.

6.2 Start-up



-  **Before using the appliance for the first time, thoroughly clean the smooth or grooved surface of the plate with lukewarm water and detergent, using a soft cloth to eliminate all trace of the rust-proofing applied in the workshop. Dry with a clean cloth.**

6.2.1 Lighting and disconnecting of burner

Check that the fat tray is in place.

Press the knob (pos. 13 fig. 1) and turn to the left as far as .

Keep the knob pressed down while repeatedly pressing the piezo ignition button (pos. 14 fig. 1) until the flame catches, you can see through aperture on the control panel. Keep the knob pressed down for another 15-20 seconds: if the flame goes out after the knob is released, start again.

Burner power regulation must be done between the max () and min. () supply position of easily selectable intermediate levels.

To turn the burner off during normal operation, turn the knob as far as "0".

Special precautions

-  It is recommended to keep cleaning the plate during use, using a scraper or a damp cloth to remove particles of food which could start smoking and causing unpleasant smells.

6.3 Cleaning and taking care of the machine

- Never clean the appliance with jets of water, whether direct or pressurised!
- Remove, empty and wash the fat tray.
- Never clean the appliance before it has cooled down.
- Rinse the surface with clean water and a soft cloth to get rid of all traces of detergent.
- When finished using the appliance, it should be cleaned thoroughly every evening.
- Before starting to clean the appliance, disconnect from the mains. The surfaces and steel parts should be washed in warm water using a neutral detergent. Avoid using abrasive or corrosive detergents which could damage the steel.
- Remove any remaining particles of food from the burner surface by using a scraper or a damp cloth.
- Thoroughly dry the appliance.
- Cleaning the appliance daily guarantees perfect long-term operation.

6.4 Turning the appliance off in case of breakdown

6.4.1 What to do in case of failure

In case of breakdown or malfunctioning or failure close the gas cock. Close the connecting cock of the unit. Call the service centre.

6.4.2 What to do in case of prolonged period of disuse

When the appliance is not to be used for a long time, clean thoroughly, as instructed in the chapter 6.5 "Appliance care and frequency of maintenance", close the connecting cock of the unit.

6.5 Appliance care and frequency of maintenance

-  **Attention! When cleaning, carefully avoid washing the appliance with direct water jets or high-pressure water!**

Cleaning must be performed when the appliance is cold.

Thorough daily cleaning of the appliance, after disconnecting it, will keep it in perfect working order and make it last longer. All steel parts should be cleaned with water and a detergent, using a damp cloth; do not use abrasive substances or corroding detergents.

Do not use steel wool, which could cause rust to form.

For the same reason, avoid touching the appliance with anything made of iron. Do not clean with sandpaper and lubricating gel paper. If absolutely necessary, you may use pumice powder.

If the appliance is extremely dirty, use a synthetic sponge (i.e. Scotchbrite sponge).

After cleaning the appliance, rinse with clean water and wipe with a clean cloth.

All maintenance and repair work must be carried out by authorized technicians only.

The appliance must be checked at least once a year. For this reason, a service agreement contract is recommended.

6 - INSTRUCTIONS FOR USE

6.6 Recommendations for the treatment of stainless "steel industrial" kitchens

6.6.1 Useful information on "stainless steel"

Industrial kitchens are generally made of "stainless steel" having the following material codes:

- 1.4016 or 1.4511 = magnetizable chromed steels
- 1.4301, 1.4401 and 1.4571 = non-magnetizable chromed steels

Chromed steels have favourable thermo-technical characteristics. In fact, they have less of a tendency to warp due to the effect of heat. Chrome-nickel steels, instead, have good corrosion resistance features. "Stainless steel" corrosion resistance is given by an inactive coat that builds up on the surface by coming into contact with oxygen.

The oxygen in the air is already enough to build up the inactive coat that allows automatic removal of anomalies and damage due to mechanical actions. The inactive coat builds up or re-builds up faster if the steel comes in contact with running water containing oxygen.

A more powerful effect is given by oxidative acids (nitric acid, oxalic acid). These acids are used if the steel has undergone strong chemical stresses, hence generally losing its inactive coat.

The inactive layer can be chemically damaged or jeopardized by reducing agents (oxygen consumption) if they come in contact with the steel, concentrated or at high temperatures. These active substances include for instance:

- saline and sulphurous substances
- chlorides (salts)
- concentrated spices such as mustard, vinegar essences, soup cubes, kitchen salt solutions, etc.

More damage can be caused by:

- outside rust (i.e. from other components, tools or incipient rust)
- iron particles (i.e. file dust)
- contact with non-ferrous metals (element build up)
- lack of oxygen (i.e. no air inlet, water lacking oxygen).

6.6.2 Warnings and advice for maintenance of "stainless steel" appliances

- "Stainless" steel equipment surfaces must be kept clean and in contact with air at all times. When not running, keep appliance doors open so as to allow air to run through it.
- Regularly remove calcium, grease, starch, and egg white deposits where rust may build up if there is lack of air. Do not use bleaching products or products containing chloride. Follow all indications given by the company concerning special soaps and cleaning methods to be used for the appliance. If no specific cleaning recommendations are available, it is necessary, however, to use detergents having a low chloride content. After cleaning, remove all soap residues with plenty of clean water and thoroughly dry the surfaces.
- Minimize contact of "stainless steel" with concentrated acids, spices, salts, etc. Even acid vapours coming from cleaning the tiles favour "stainless steel" corrosion.
- Particularly for pots and multiple appliances, it is not recommended to load the cooking chamber only with food having a high salt content.

It is preferable to cook different food together, i.e. fatty dishes or vegetables containing acids.

- Avoid damaging the "stainless steel" surface, in particular with different metals. Residues from other metals help build up the formation of chemical microelements that may cause rust. At any rate, it is appropriate to avoid contact between iron and steel since it produces rust. Any contact between "stainless steel" and iron (steel wool, pipeline chips, chalybeate waters) can start corrosion phenomena.
- As for mechanical cleaning, it is recommended to use only steel wool or natural, plastic or steel bristle brushes. Steel wool or brushes with "stainless steel" can cause rust due to rubbing. Newly formed rust spots can be removed with slightly abrasive liquid

soaps or fine-grained sand paper. Larger rust spots can be removed with 2-3% of hot oxalic acid solution. If these cleaning products do not do the job, a nitric acid (10%) treatment is required.

 **Attention! These treatments can be carried out only by expert personnel according to current regulations!**

6.6.3 The 2002/96/EC (WEEE) Directive: information to users



This informational note is meant only for owners of equipment marked with the symbol shown in fig. A on the adhesive label featuring the technical specifications applied on the actual product (the label also giving the serial number).

This symbol indicates that the product is classified, according to the regulations in force, as an item of electrical and electronic equipment and conforms to EU Directive 2002/96/EC (WEEE) meaning that, at the end of its service life, it must be treated separately from domestic waste, i.e. it must be handed in free of charge to a separate waste electrical and electronic equipment collection centre or returned to the reseller when buying a new equivalent item of equipment.

The user is responsible for delivering the unit at the end of its life to the appropriate collection facilities. Failure to do so shall result in the user being subject to the penalties prescribed by the legislation in force on waste.

Suitable separated collection so that the unit no longer used can be sent off for environmentally compatible recycling, treatment and disposal helps avoid possible negative effects on the environment and on health and facilitates the recycling of the product's component materials.

For more detailed information on available collection systems, contact the local waste disposal service or the shop you purchased the unit from.

Producers and importers fulfil their responsibility for environmentally compatible recycling, treatment and disposal both directly and by joining a collective scheme.

WARNING

THE MANUFACTURER CANNOT BE HELD RESPONSIBLE
FOR ANY INACCURACIES IN THIS BOOKLET DUE
TO COPYING OR PRINTING ERRORS.
DUE TO ITS POLICY OF CONTINUAL PRODUCT IMPROVEMENT,
THE MANUFACTURER RESERVES THE RIGHT
TO MAKE ANY CHANGES DEEMED NECESSARY.
**THE MANUFACTURER CANNOT BE HELD RESPONSIBLE
IF THE INSTRUCTIONS CONTAINED IN THIS MANUAL
ARE NOT OBSERVED.**